

PRODUCT SHEET

SPECIFICATIONS

VITA BELLA
APPLIANCE PULLS

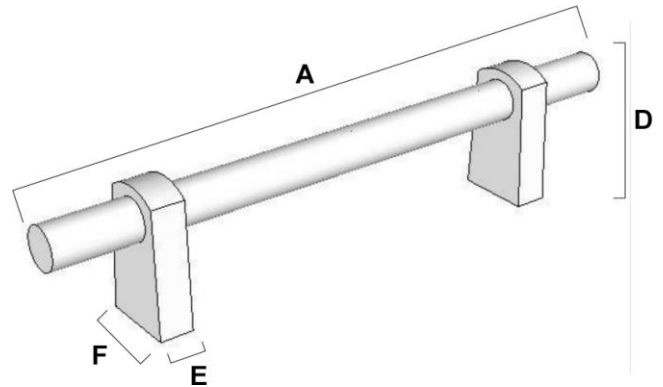

FEATURES

- Transitional styling
- Multiple finishes
- Concealed installation

WARRANTY

Limited lifetime

FINISHES

- Matte Black (MB)
- Champagne (CHP)
- Matte Nickel (MN)
- Champagne/Matte Black (CHP/MB)
- Matte Nickel/Matte Black (MN/MB)

MATERIAL

Aluminum

Item#	A	B	C	D	E (L)	F (W)
D2801-12	14 3/4"	12"	5/8"	2-1/8"	7/16"	11/16"
D2801-18	20 3/4"	18"	5/8"	2-1/8"	7/16"	11/16"

KEY :

- A Overall Length
- B Center to Center
- C Bar Width
- D Projection
- E Mount Length
- F Mount Width

NOTE: Dimensions and specifications are subject to change without notice.