

Prior to Installation:

This item is recommended to be installed by a licensed plumber or professional only. Please ensure to observe all local and building code requirements. Shut off water supply prior to installation.

Installation Instructions For Shower Set With:

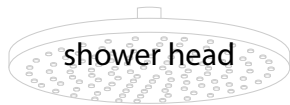

shower head



shower arm



valve & trim

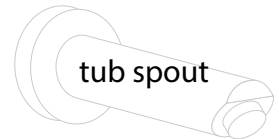

tub spout

Tools You May Need:

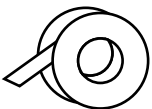

plumber's
tape

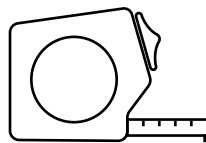

tape
measure



allen
wrench

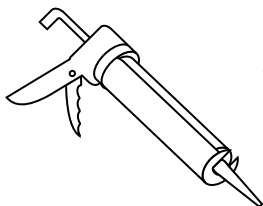

caulk

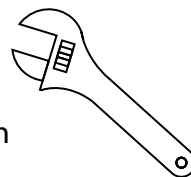

wrench

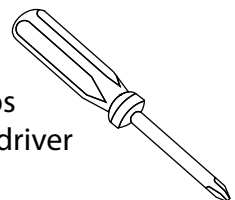

phillips
screwdriver

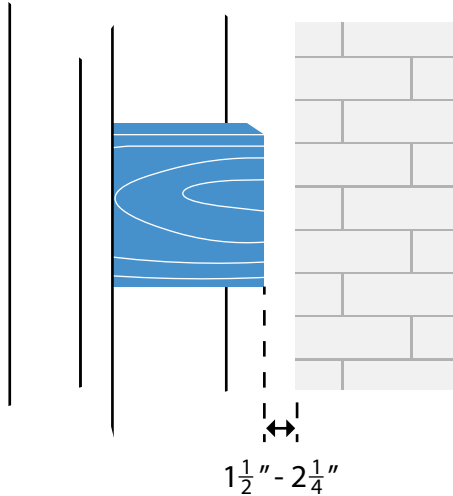

1. Prepare Location

Locate studs in the wall. Add wood blocking behind the finished wall and ceiling where the mixer, shower arm, and tub spout will be placed. Total distance from finished wall should be between 1 1/2" and 2 1/4" for the valve.

2. Mount Valve

Rough-in valve mounts to internal pipes. Any further support needed can be manually done by a licensed plumber or professional.

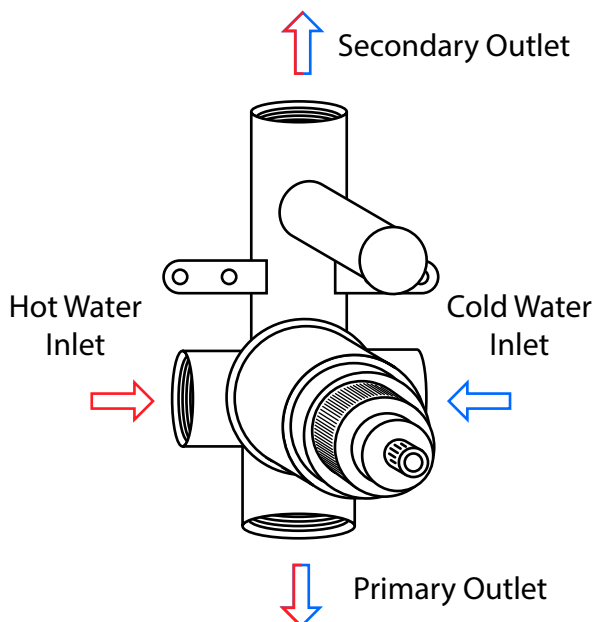
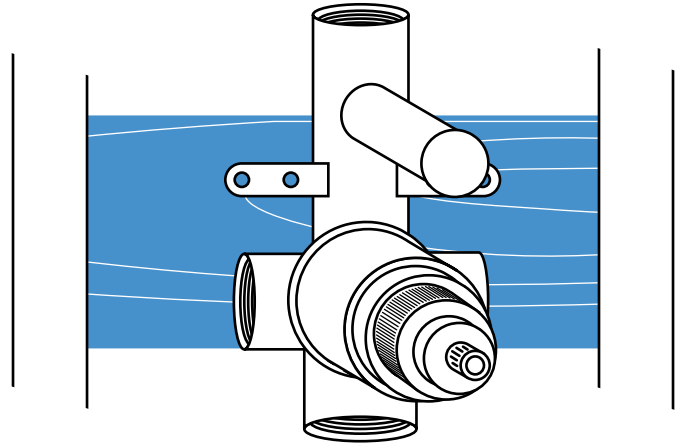

3. Connect Hot and Cold Water Lines

Connect the hot and cold water lines. The valve indicates which inlet is for each water temperature. Be sure to pressure test the fittings before finishing the wall.

4. Finish Wall

Close the wall and finish with desired exterior. Don't forget to measure and cut holes for valve, shower arm, and tub spout if using acrylic panels.

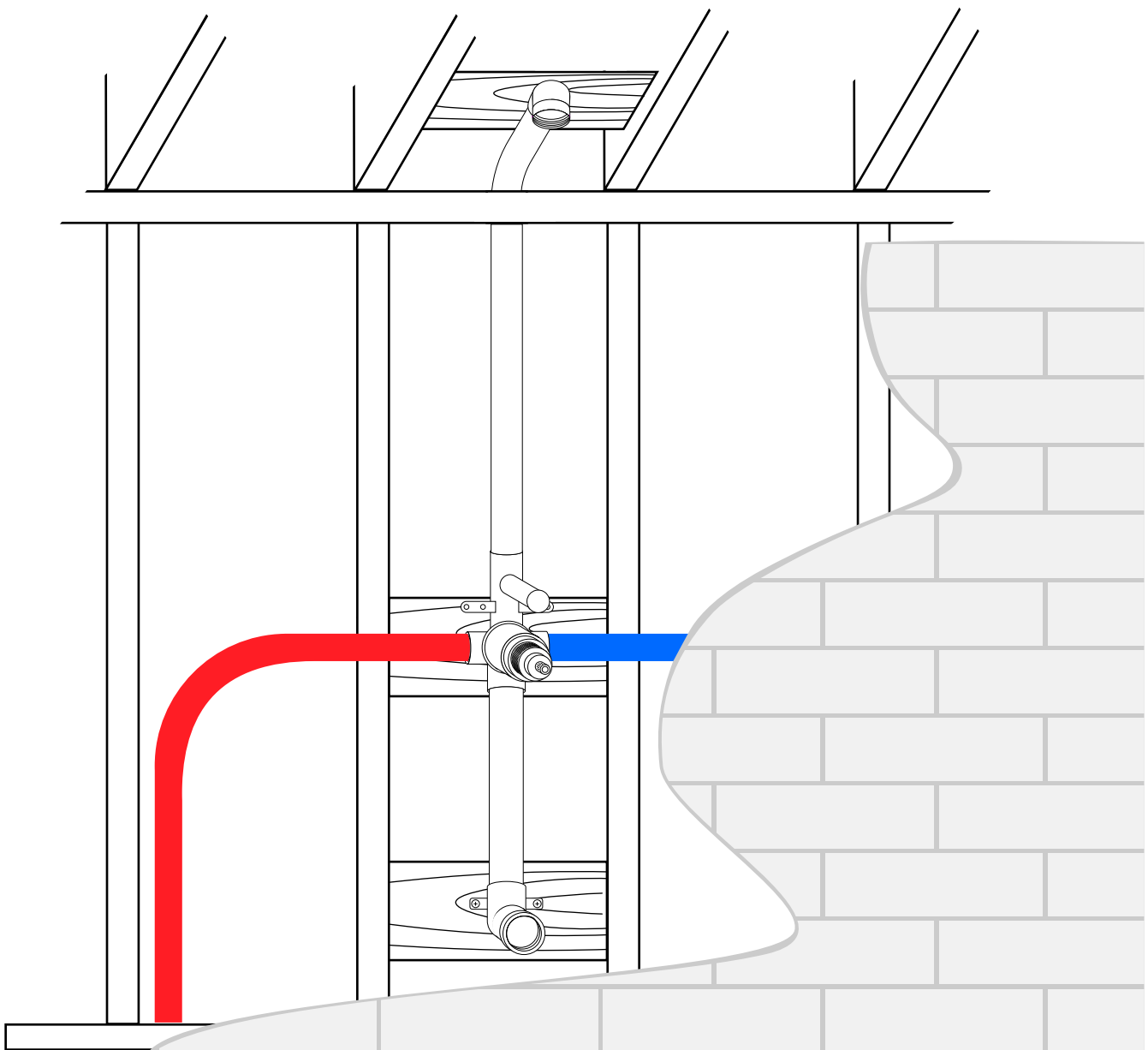

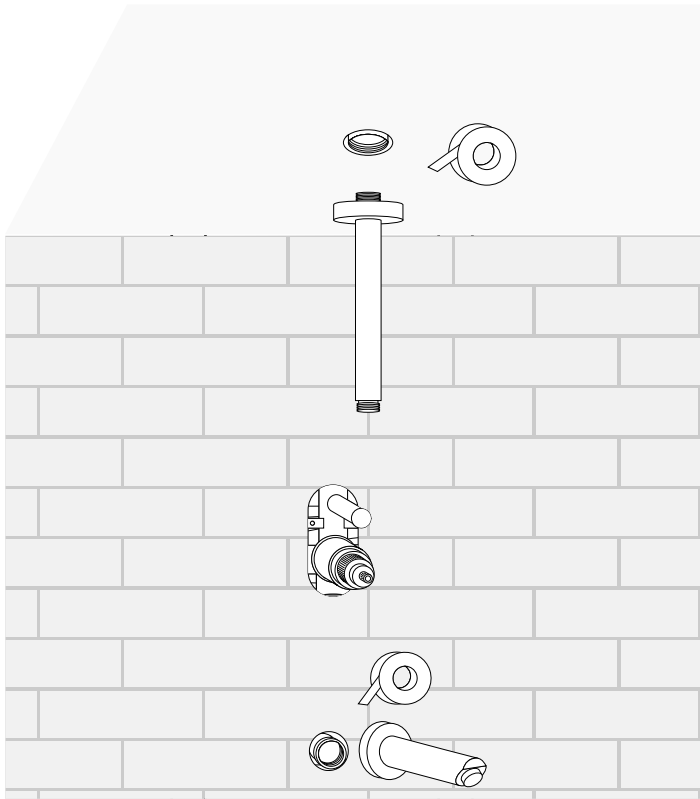

5. Install Shower Arm and Tub Spout

Slide on the shower arm plate and install arm with plumber's tape. Slide on the tub spout plate and install spout with plumber's tape.

Be careful not to cross thread pipes.

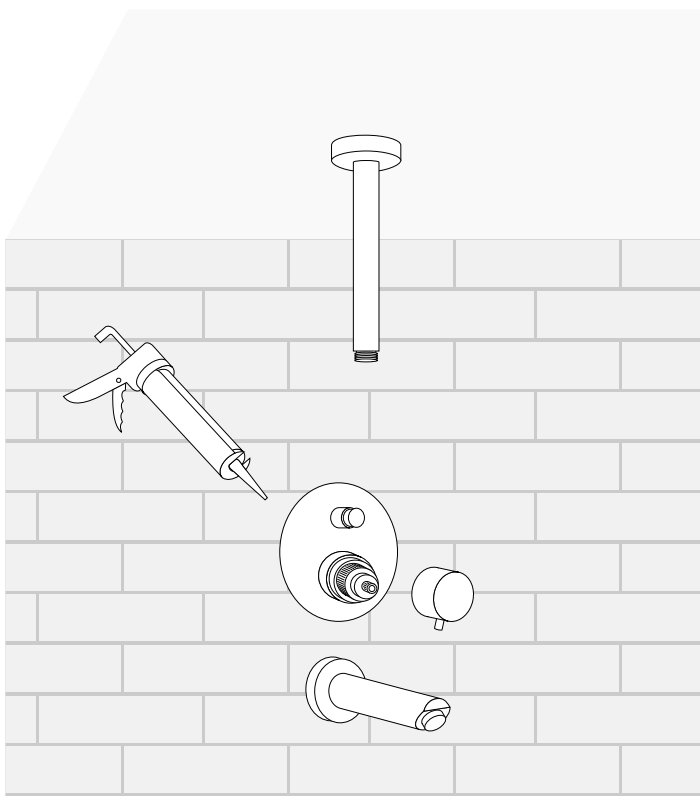

6. Install Cover Plate and Attach Handle

Install the cover plate with a bead of silicone. Attach the mixer handle to the valve. Secure firmly by tightening with allen wrench.

7. Shower Accessories

Complete your installation by adding the preferred shower accessories; shower basket, wire soap dish, and train rack.

shower basket

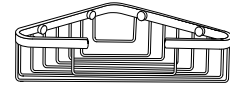

wire soap dish

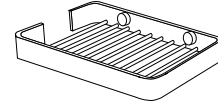

train rack

