

Following these mounting instructions with the hardware included will be more than sufficient to support wall mounted installation.

Included Installation Hardware

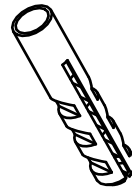

x4 screw



x4 wall anchor

Tools You May Need

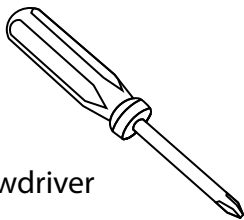

Screwdriver



Level

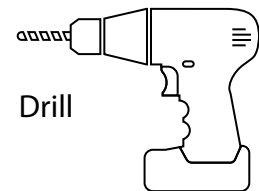

Drill

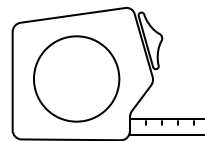

Tape Measure

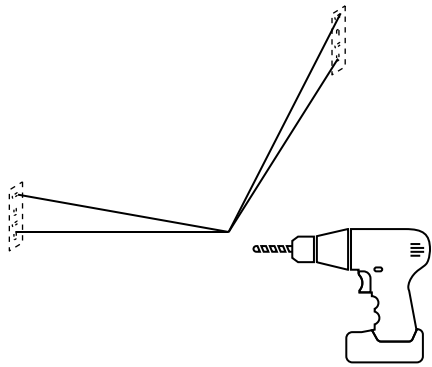

1. Drill Anchor Holes

Identify installation location. Mark mounting plates on wall and drill holes the size of the anchors.

2. Install Anchors

Tap anchors into predrilled holes.

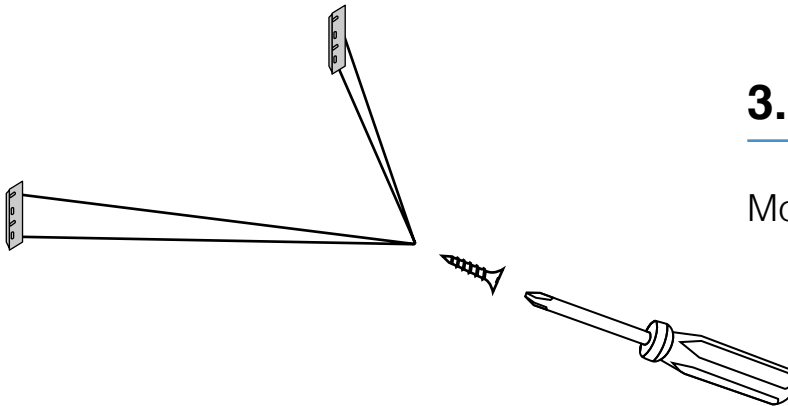
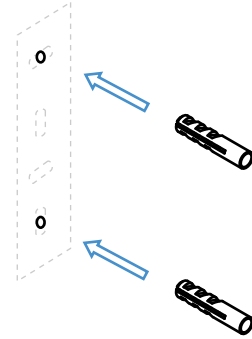

3. Mount Brackets

Mount bracket with screws.

4. Mount Train Rack

Install train rack over mounting brackets and tighten with screwdriver.

